



Specification

- Material: Aluminium
- Max Working Pressure: 10 Bar
- Connection: ½"
- Warranty: 5 Year Manufacture
- All products tested in accordance with EN442

Features and Benefits

- Manufactured in aluminium to give fast response and excellent heat output
- Fully recyclable at the end of its life
- Suitable for any central heating system
- Lightweight and resistant to corrosion
- Oval shaped bars for added style

Product Code New	Height (mm)	Length (mm)	Depth (mm)	Pipe Centres	Output (Watts)	Output (BTUs)	Weight KG
136050	800	300	78-88	270	205	699	5
136056	800	500	78-88	455	342	1166	6
136051	1000	300	78-88	270	273	931	6
136057	1000	500	78-88	455	456	1555	8
136052	1200	300	78-88	270	324	1105	7
136058	1200	500	78-88	455	542	1851	10
136053	1400	300	78-88	270	376	1282	8
136059	1400	500	78-88	455	627	2139	11
136054	1600	300	78-88	270	461	1572	9
136055	1800	300	78-88	270	496	1692	10



800X300MM

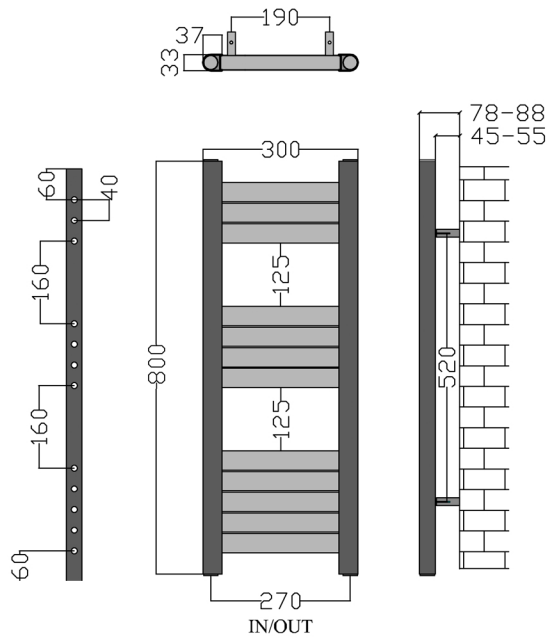

800X500MM

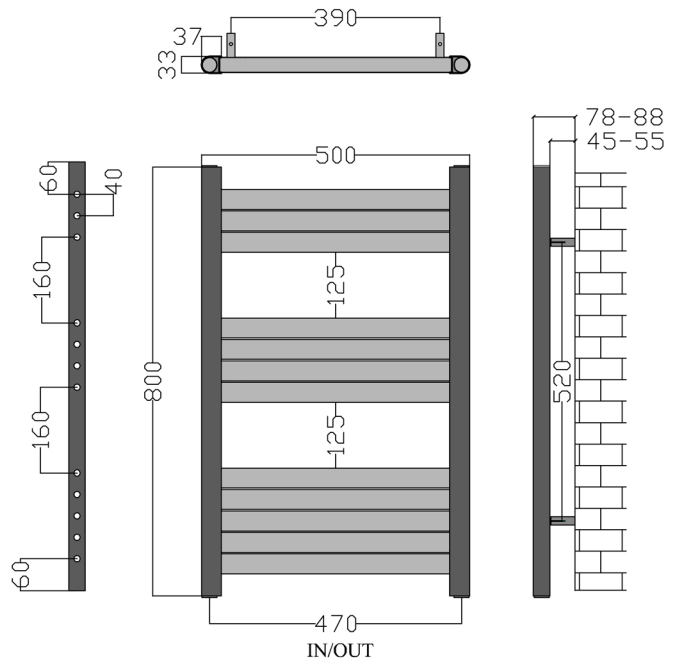

1000X300MM

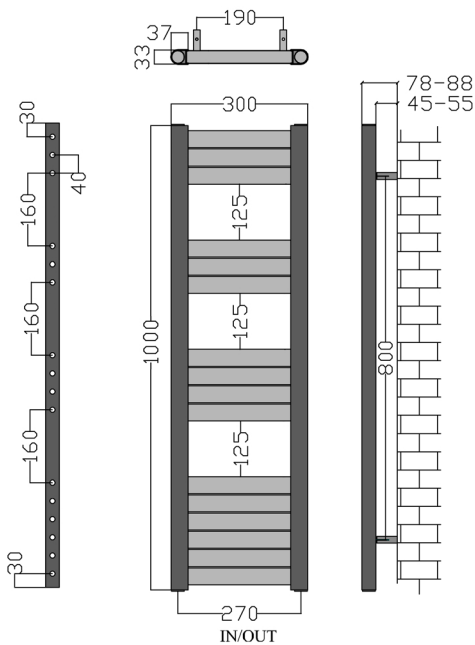

1000X500MM

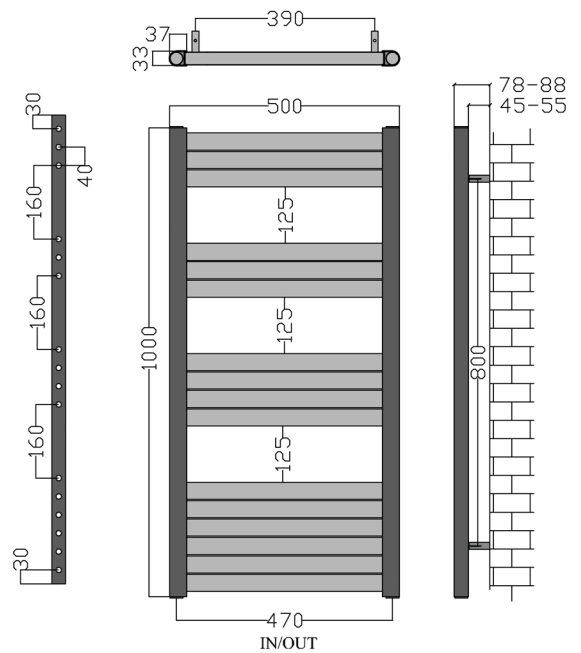

1200X300MM

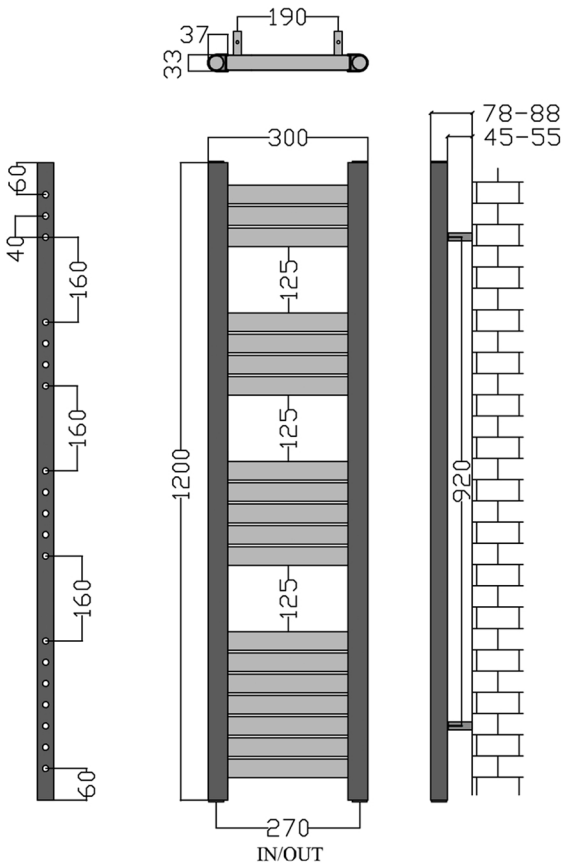

1200X500MM

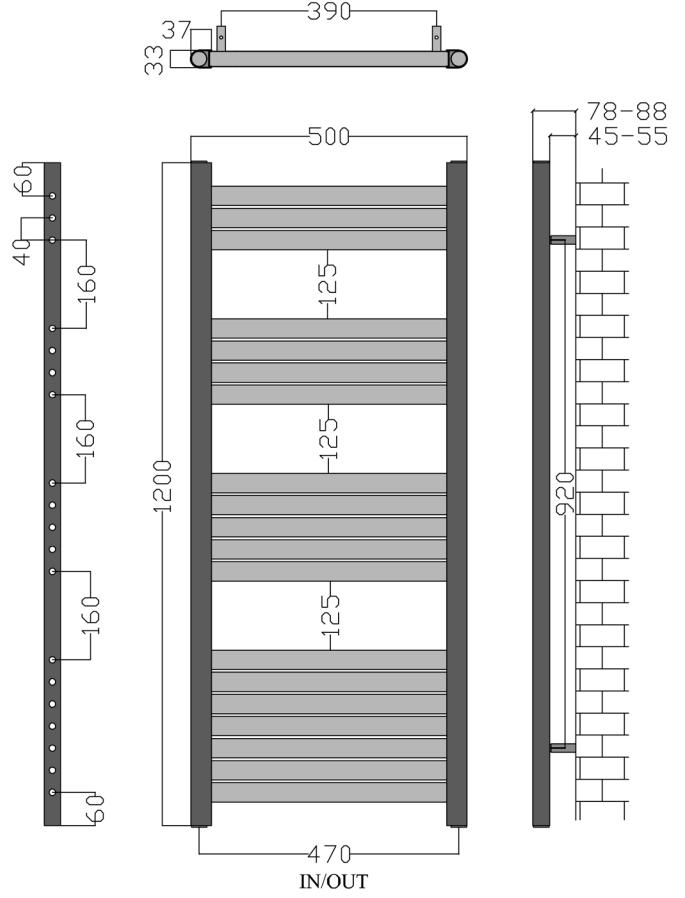

1400X300MM

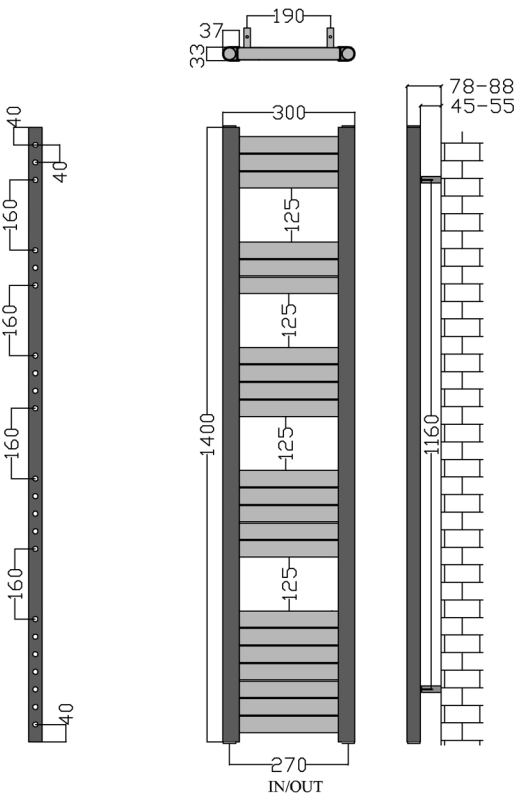

1400X500MM

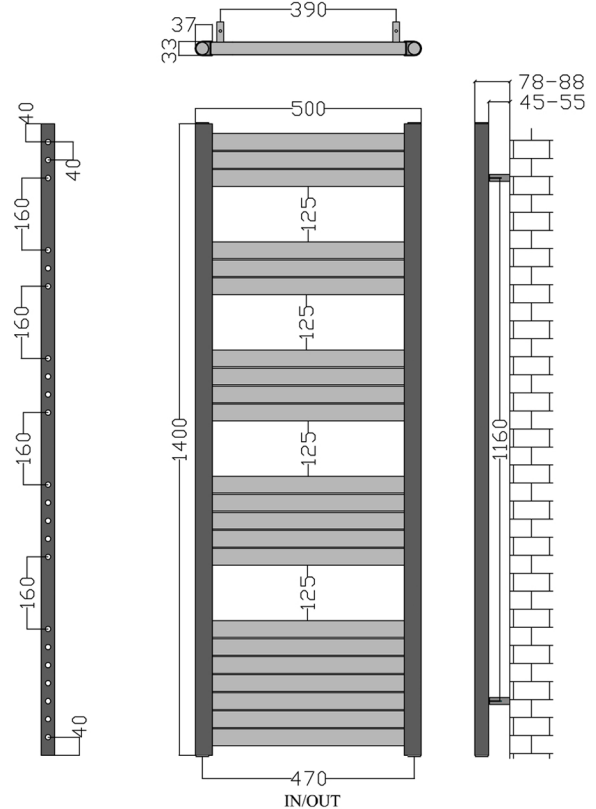

1600X300MM

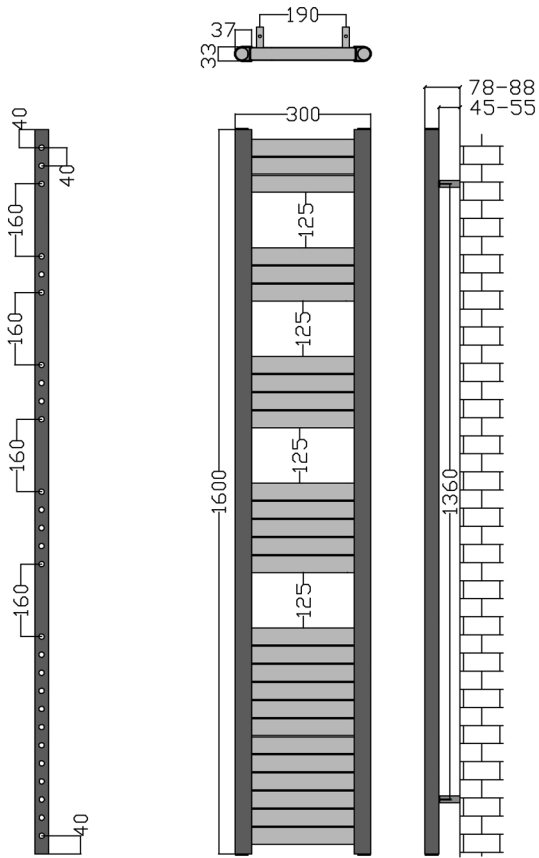

1600X300MM

